

# ORCHID SERIES

# ORCHID SERIES



**ORCHID SERIES** is unique due to its various selectable frames for different applications: round/ square, fixed/ rotatable, symmetric/ asymmetric, flat/ deep, oval hole/ circular hole frame.

UGR <16  
Low glare

IP20 IP40	220-240V	6-30 WATTS	UGR <16
1-10V	5 YRS Warranty	+/- 30°	355°
			LOW GLARE

## PHYSICAL

Body Aluminum(Frame)

## OPTICAL

Diffuser PMMA

Light Emission Direct

## ELECTRICAL

Lamp LED

Color Rendering >95

Color Temperature 3000K - 4000K - 5000K - 5700K

Gear 220-240 VAC | 50-60Hz

Ambient Temp. -10°C - 40°C

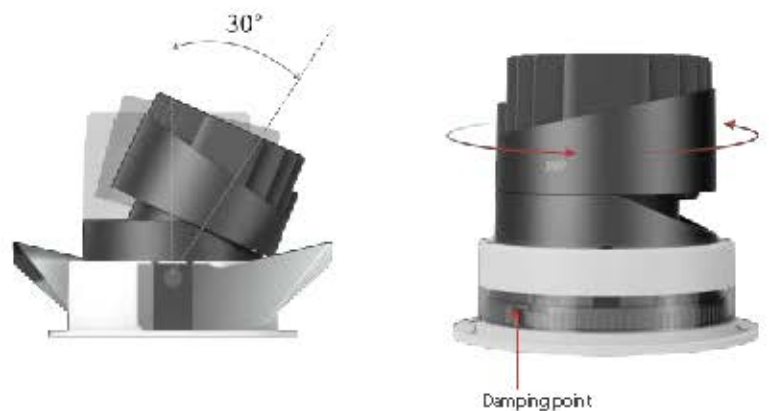

Adjustable

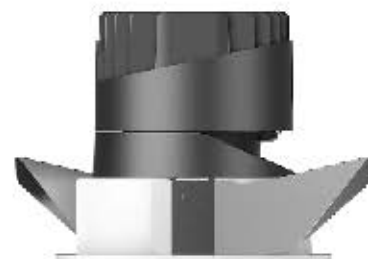

Fixed

ORCHID 1.5.6



ORCHID 1.5.7



ORCHID 1.5.8



ORCHID 1.5.9

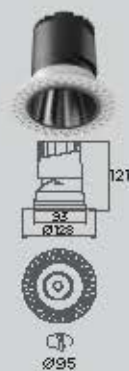

ORCHID 1.6.1

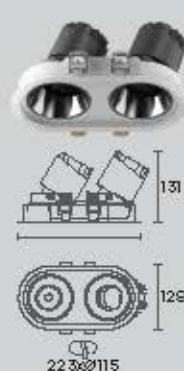

ORCHID 1.6.2

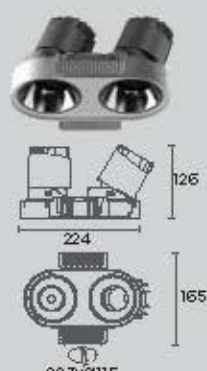

ORCHID 1.6.3



ORCHID 1.6.4

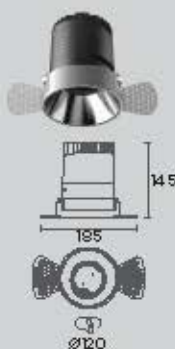

ORCHID 1.6.5



ORCHID 1.6.6

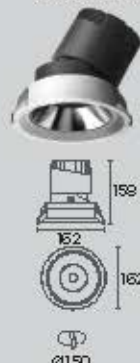

ORCHID 1.6.7

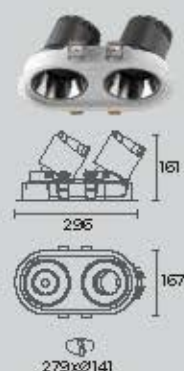

ORCHID 1.6.8

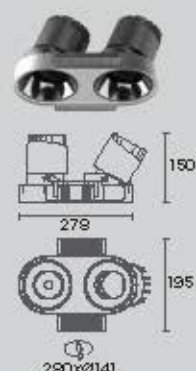

## ORCHID SERIES

	Rated Power (W)	Dimensions (mm)	Cut out dimensions (mm)	IP RATING	Beam Angle
<b>ORCHID 1.5.6</b>	20W	Ø106xH119	Ø95	40	12°, 15°, 24°, 38°, 60°
<b>ORCHID 1.5.7</b>	20W	Ø162xH118	Ø96	40	12°, 15°, 24°, 38°, 60°
<b>ORCHID 1.5.8</b>	20W	L106xW106xH119	Ø95	40	12°, 15°, 24°, 38°, 60°
<b>ORCHID 1.5.9</b>	20W	L128xW128xH121	Ø95	40	12°, 15°, 24°, 38°, 60°
<b>ORCHID 1.6.1</b>	2x20W	L240xW128xH131	L223xØ115	40	12°, 15°, 24°, 38°, 60°
<b>ORCHID 1.6.2</b>	2x20W	L224xW165xH126	L223xØ115	40	12°, 15°, 24°, 38°, 60°
<b>ORCHID 1.6.3</b>	30W	Ø132xH145	Ø120	40	10°, 15°, 24°, 38°
<b>ORCHID 1.6.4</b>	30W	Ø185xH145	Ø120	40	10°, 15°, 24°, 38°
<b>ORCHID 1.6.5</b>	30W	L133xW133xH145	Ø120	40	10°, 15°, 24°, 38°, 55°
<b>ORCHID 1.6.6</b>	30W	Ø162xH158	Ø150	40	10°, 15°, 24°, 38°, 55°
<b>ORCHID 1.6.7</b>	30W	L296xW167xH161	L279xØ141	40	10°, 15°, 24°, 38°, 55°
<b>ORCHID 1.6.8</b>	30W	L278xW195xH150	L280xØ141	40	10°, 15°, 24°, 38°, 55°

## ORDERING CODE

SERIES NAME - PRODUCT RANGE - IP - CCT - OPTICS - CONTROL

ORCHID	1.5.6	40 IP40	30 3000K	10 10°	1 ON-OFF
	1.5.7		40 4000K	12 12°	2 1-10V
	1.5.8		60 6000K	15 15°	3 DALI
	1.5.9			24 24°	
	1.6.1			38 38°	
	1.6.2			55 55°	
	1.6.3			60 60°	
	1.6.4				
	1.6.5				
	1.6.6				
	1.6.7				
	1.6.8				



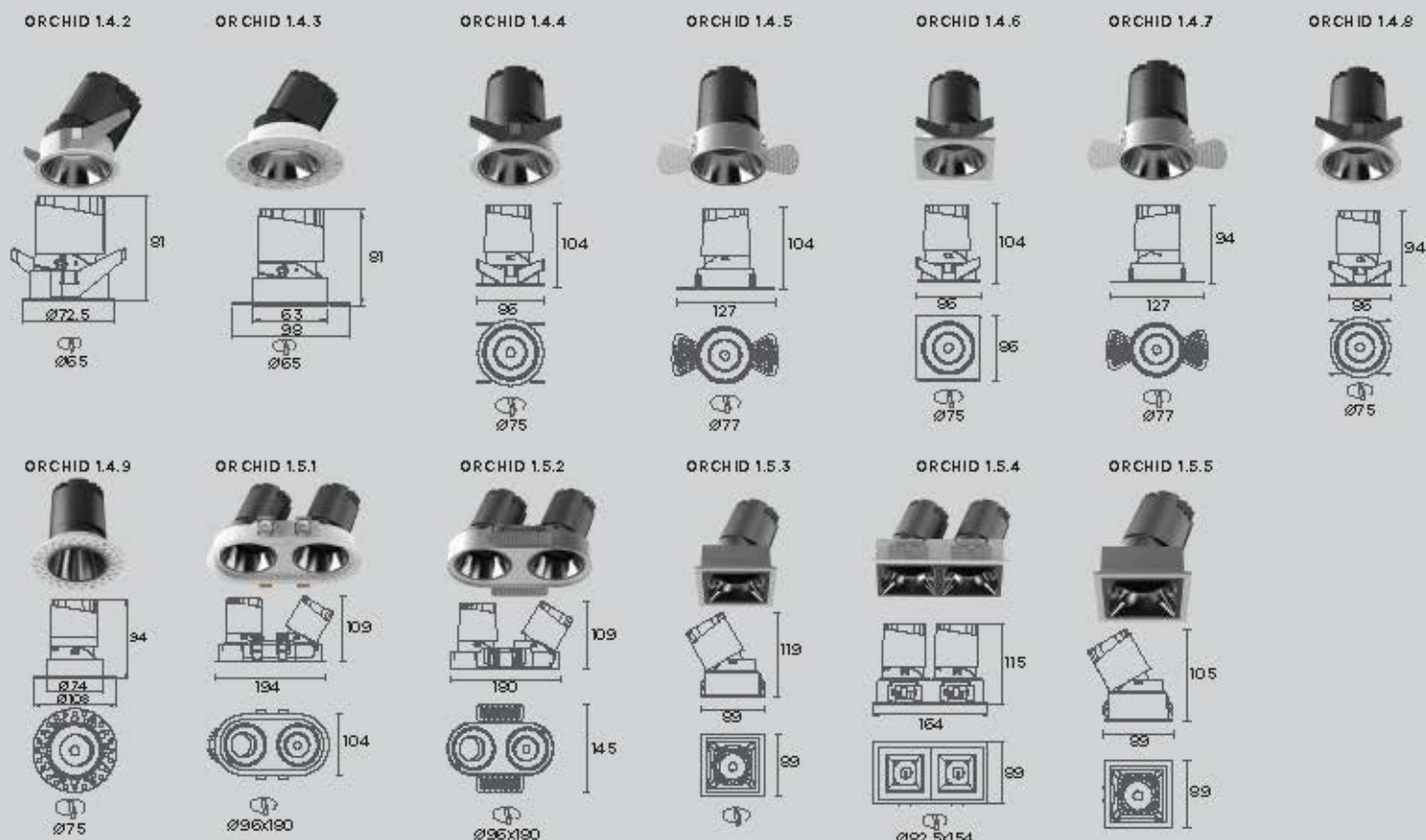

## ORCHID SERIES

	Rated Power (W)	Dimensions (mm)	Cut out dimensions (mm)	IP RATING	Beam Angle
<b>ORCHID 1.4.2</b>	10W	Ø72.5xH81	Ø65	40	10°, 15°, 24°, 38°, 55°
<b>ORCHID 1.4.3</b>	10W	Ø98xH81	Ø65	40	10°, 15°, 24°, 38°, 55°
<b>ORCHID 1.4.4</b>	12W	Ø86xH104	Ø75	40	10°, 15°, 24°, 38°
<b>ORCHID 1.4.5</b>	12W	Ø127xH104	Ø77	40	10°, 15°, 24°, 38°
<b>ORCHID 1.4.6</b>	12W	L86xW86xH104	Ø75	40	10°, 15°, 24°, 38°, 50°
<b>ORCHID 1.4.7</b>	12W	Ø127xH94	Ø77	40	10°, 15°, 24°, 38°, 55°
<b>ORCHID 1.4.8</b>	12W	Ø86xH94	Ø75	40	10°, 15°, 24°, 38°, 55°
<b>ORCHID 1.4.9</b>	12W	Ø108xH94	Ø75	40	10°, 15°, 24°, 38°, 55°
<b>ORCHID 1.5.1</b>	2x12W	L194xW104xH109	Ø96x180	40	10°, 15°, 24°, 38°
<b>ORCHID 1.5.2</b>	2x12W	L180xW145xH109	Ø96x180	40	10°, 15°, 24°, 38°
<b>ORCHID 1.5.3</b>	12W	L89xW89xH119	L82xW82	40	10°, 15°, 24°, 38°, 50°
<b>ORCHID 1.5.4</b>	2x12W	L164xW89xH115	L154xW82.5	40	10°, 15°, 24°, 38°, 50°
<b>ORCHID 1.5.5</b>	12W	L89xW89xH105	L82xW82	40	10°, 15°, 24°, 38°, 55°

## ORDERING CODE

SERIES NAME - PRODUCT RANGE - IP - CCT - OPTICS - CONTROL

ORCHID	1.4.2	40 IP40	30 3000K	10 10°	1 ON-OFF
	1.4.3		40 4000K	15 15°	2 1-10V
	1.4.4		60 6000K	24 24°	3 DALI
	1.4.5			38 38°	
	1.4.6			50 50°	
	1.4.7			55 55°	
	1.4.8				
	1.4.9				
	1.5.1				
	1.5.2				
	1.5.3				
	1.5.4				
	1.5.5				

ORCHID 1.3.5

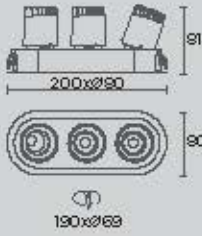

ORCHID 1.3.6

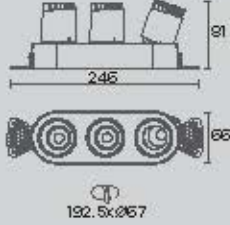

ORCHID 1.3.7

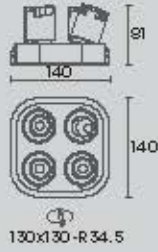

ORCHID 1.3.8

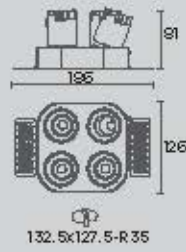

ORCHID 1.3.9

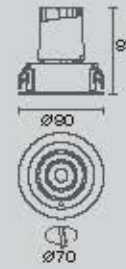

ORCHID 1.4.1

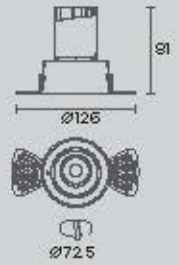

## ORCHID SERIES

	Rated Power (W)	Dimensions(mm)	Cut out dimensions(mm)	IP RATING	Beam Angle
<b>ORCHID 1.3.5</b>	6W	Ø58xH73	Ø50	40	10°,15°,24°, 38°
<b>ORCHID 1.3.6</b>	6W	Ø97xH73	Ø52	40	10°,15°,24°, 38°
<b>ORCHID 1.3.7</b>	6W	L60xW60xH73	Ø50	40	10°,15°,24°, 38°
<b>ORCHID 1.3.8</b>	6W	Ø65xH73	Ø50-55	40	10°,15°,24°, 38°
<b>ORCHID 1.3.9</b>	6W	Ø80xH81	Ø70	40	10°,15°,24°, 38°
<b>ORCHID 1.4.1</b>	6W	Ø126xH81	Ø72.5	40	10°,15°,24°, 38°

## ORDERING CODE

## SERIES NAME - PRODUCT RANGE - IP - CCT - OPTICS - CONTROL

ORCHID	1.3.5	40	IP40	30	3000K	10	10°	1	ON-OFF
	1.3.6			40	4000K	15	15°	2	1-10V
	1.3.7			60	6000K	24	24°	3	DALI
	1.3.8					38	38°		
	1.3.9								
	1.4.1								

ORCHID 1.2.7

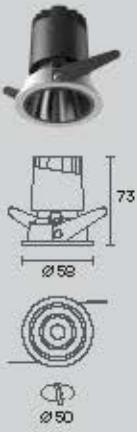

ORCHID 1.2.8

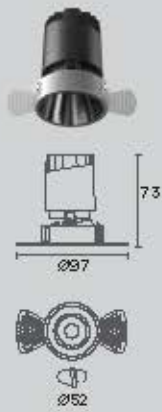

ORCHID 1.2.9

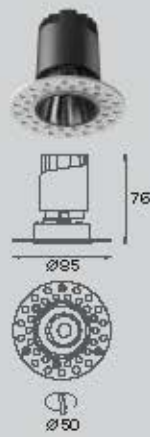

ORCHID 1.3.1

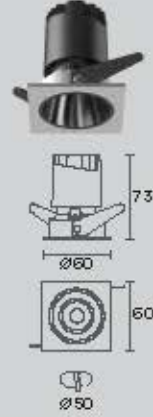

ORCHID 1.3.2

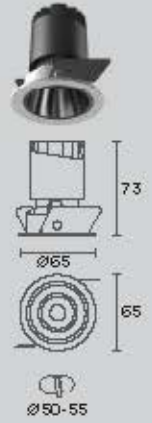

ORCHID 1.3.3

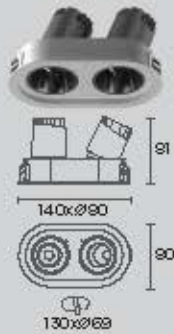

ORCHID 1.3.4

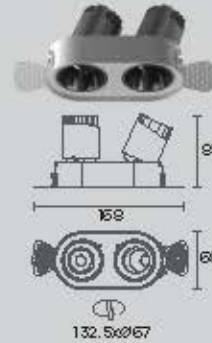

## ORCHID SERIES

	Rated Power (W)	Dimensions(mm)	Cut out dimensions(mm)	IP RATING	Beam Angle
<b>ORCHID 1.2.7</b>	6W	Ø58xH73	Ø50	40	10°, 15°, 24°, 38°
<b>ORCHID 1.2.8</b>	6W	Ø97xH73	Ø52	40	10°, 15°, 24°, 38°
<b>ORCHID 1.2.9</b>	6W	L60xW60xH73	Ø50	40	10°, 15°, 24°, 38°
<b>ORCHID 1.3.1</b>	6W	Ø65xH73	Ø50-55	40	10°, 15°, 24°, 38°
<b>ORCHID 1.3.2</b>	6W	Ø80xH81	Ø70	40	10°, 15°, 24°, 38°
<b>ORCHID 1.3.3</b>	6W	L140xW80xH81	130xØ69	40	10°, 15°, 24°, 38°
<b>ORCHID 1.3.4</b>	6W	L168xW68xH81	132.5xØ67	40	10°, 15°, 24°, 38°

## ORDERING CODE

## SERIES NAME - PRODUCT RANGE - IP - CCT - OPTICS - CONTROL

ORCHID	1.2.7	40	IP40	30	3000K	10	10°	1	ON-OFF
	1.2.8	40		4000K	15	15°		2	1-10V
	1.2.9	60		6000K	24	24°		3	DALI
	1.3.1					38	38°		
	1.3.2								
	1.3.3								
	1.3.4								

ORCHID 1.1.7

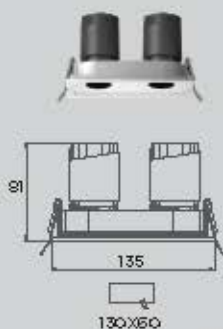

ORCHID 1.1.8

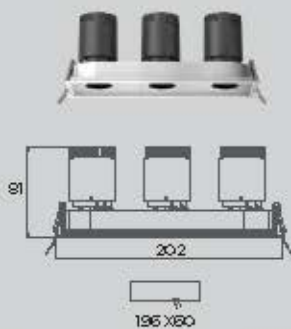

ORCHID 1.1.9

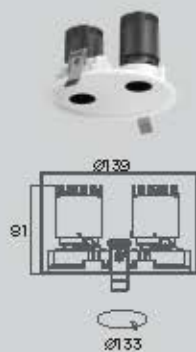

ORCHID 1.2.1

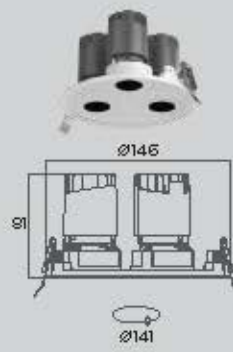

ORCHID 1.2.2

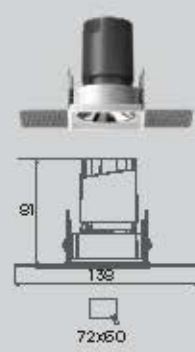

ORCHID 1.2.3

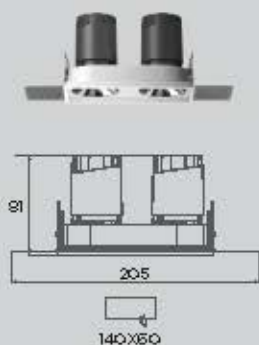

ORCHID 1.2.4

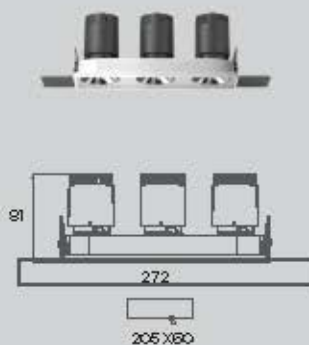

ORCHID 1.2.5

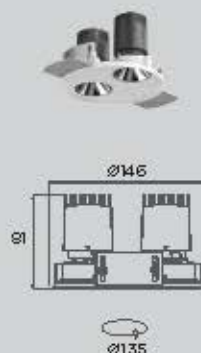

ORCHID 1.2.6

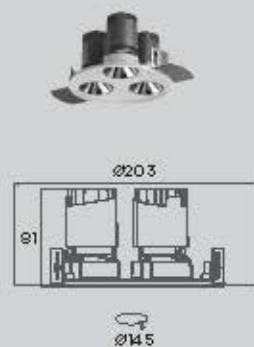

## ORCHID SERIES

	Rated Power (W)	Dimensions (mm)	Cut out dimensions (mm)	IP RATING
<b>ORCHID 1.1.7</b>	6W	L135xW68xH81	L130xW60	20
<b>ORCHID 1.1.8</b>	6W	L202xW68xH81	L196xW60	20
<b>ORCHID 1.1.9</b>	6W	Ø139xH81	Ø133	40
<b>ORCHID 1.2.1</b>	6W	Ø146xH81	Ø141	40
<b>ORCHID 1.2.2</b>	6W	L138xW68xH81	L72xW60	40
<b>ORCHID 1.2.3</b>	6W	L205xW68xH81	L140xW60	40
<b>ORCHID 1.2.4</b>	6W	L272xW68xH81	L205xW60	40
<b>ORCHID 1.2.5</b>	6W	Ø146xH81	Ø135	40
<b>ORCHID 1.2.6</b>	6W	Ø203xH81	Ø145	40

## ORDERING CODE

SERIES NAME - PRODUCT RANGE - IP - CCT - OPTICS - CONTROL

ORCHID	1.1.7	20 IP20 30 3000K	NA	1 ON-OFF
	1.1.8	40 IP40 40 4000K		2 1-10V
	1.1.9	60 6000K		3 DALI
	1.2.1			
	1.2.2			
	1.2.3			
	1.2.4			
	1.2.5			
	1.2.6			



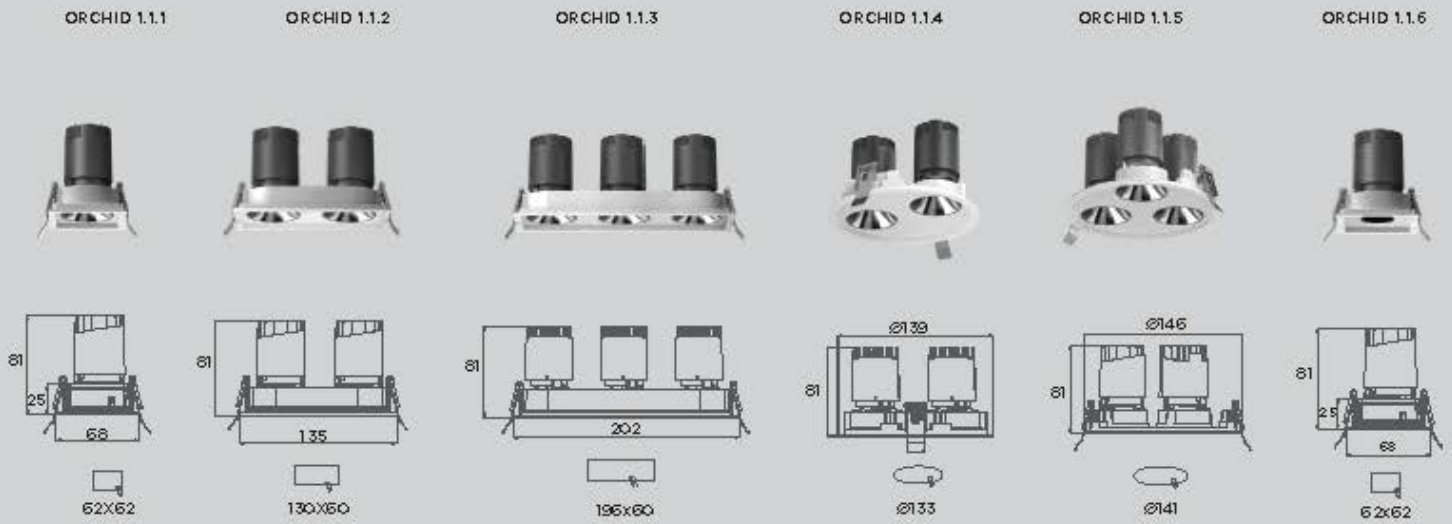

## ORCHID SERIES

	Rated Power (W)	Dimensions (mm)	Cut out dimensions (mm)	IP RATING
<b>ORCHID 1.1.1</b>	6W	L68xW68xH81	L62xW62	40
<b>ORCHID 1.1.2</b>	6W	L135xW68xH81	L130xW60	40
<b>ORCHID 1.1.3</b>	6W	L202xW68xH81	L196xW60	20
<b>ORCHID 1.1.4</b>	6W	Ø138xH81	Ø133	20
<b>ORCHID 1.1.5</b>	6W	Ø146xH81	Ø141	40
<b>ORCHID 1.1.6</b>	6W	L68xW68xH81	L62xW62	40

## ORDERING CODE

### SERIES NAME - PRODUCT RANGE - IP - CCT - OPTICS - CONTROL

ORCHID	1.1.1	20 IP20 30 3000K	NA	1 ON-OFF
	1.1.2	40 IP40 40 4000K		2 1-10V
	1.1.3	60 6000K		3 DALI
	1.1.4			
	1.1.5			
	1.1.6			